

# 8 mm CHIPPROP

## Miniature proportional valve



- 2/2 NC proportional cartridge valve
- Very compact design (Ø 8 x 19 mm)
- Low power consumption (1 W)
- Excellent flow to size ratio

### Technical features

**Medium:**  
Neutral or aggressive gases and liquids

**Operation:**  
2/2 NC proportional

**Orifice size:**  
0,2; 0,6; 1,0 mm

**Max. operating pressure:**  
0,1 bar (orifice 1,0 mm)  
5 bar (orifice 0,6 mm)  
8 bar (orifice 0,2 mm)

**Mounting:**  
Cartridge

**Size:**  
Ø 8 mm x 19 mm

**Flow characteristics:**  
kv 0,02 (orifice 0,2 mm);  
kv 0,12 (orifice 0,6 mm);  
kv 0,16 (orifice 1,0 mm);  
See flow curves

**Temperatures:**  
Temperature: +5°C-50°C  
Ambient temperature:  
+0 ... +65°C (+32 ... +149°F)  
Media temperature:  
+0 ... +40°C (+32 ... +104°F)

**Material:**  
Body material in contact with media: Stainless steel, brass  
Seal material: FPM

### Electrical details

Voltage	24 V d.c.
Rating	50% E.D.
Voltage tolerance	± 10%
Power consumption	1 W
Electrical insulation	500 V a.c.
Insulation class	F (155°C)

### Following options on request

Voltage
Seal material
Operation (2/2 NO proportional, 3/2 NC proportional)

### Technical data – standard models

Symbol	Orifice (mm)	Operating Pressure (bar)	kv*1 (-)	Current (mA)	Body material in contact with media	Seal material	Model
	0,2	0 ... 8,0	0,02	0 ... 20	Stainless steel, brass	FPM	14-216CA00221
	0,6	0 ... 5,0	0,12	0 ... 20	Stainless steel, brass	FPM	14-216CA06021
	1,0	0 ... 0,1	0,16	0 ... 20	Stainless steel, brass	FPM	14-216CA01021

\*1) Cv = 0,07 kv

## Typically flow curves

CHIPPROP ORIFICE 0,2 mm

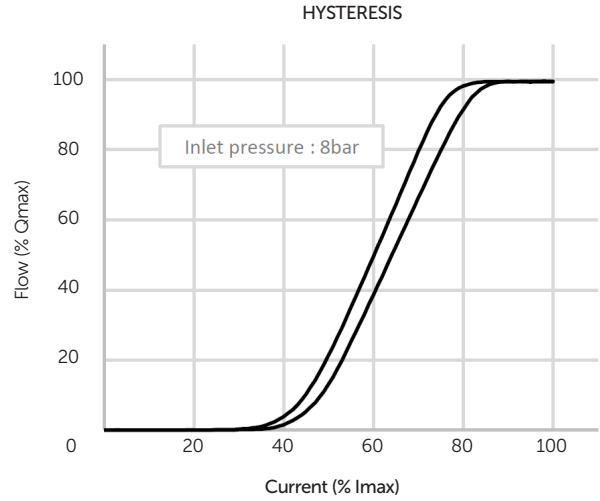
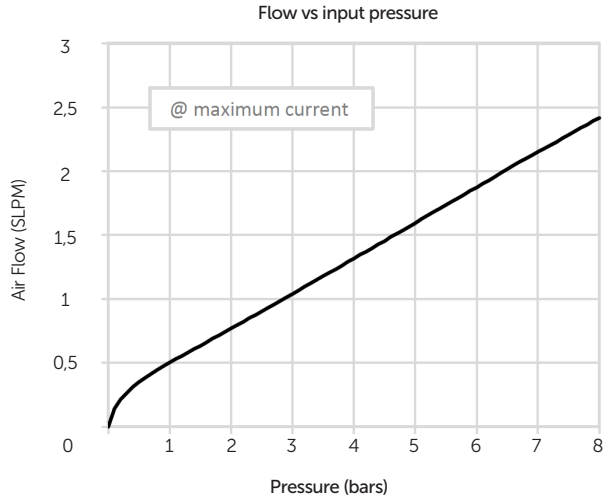

CHIPPROP ORIFICE 0,6 mm

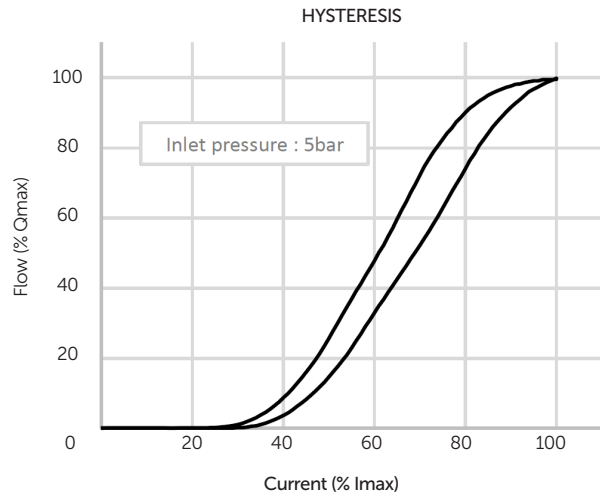
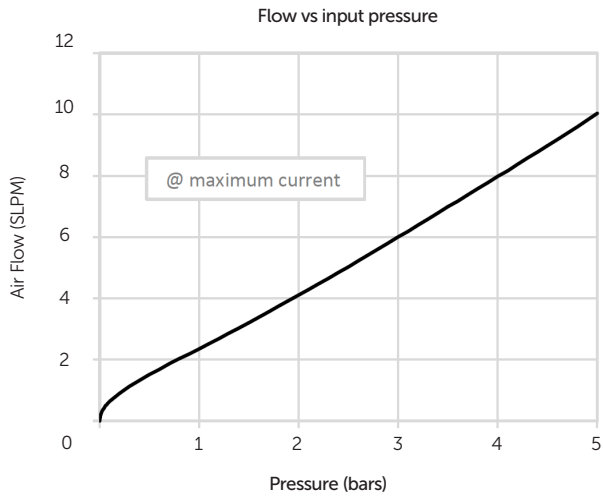

CHIPPROP ORIFICE 1,0 mm

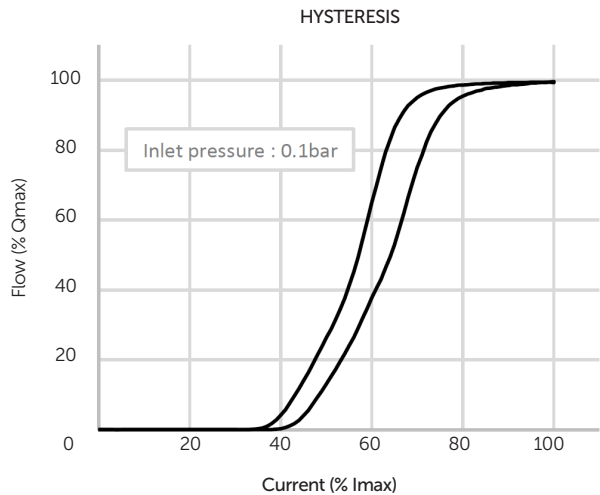
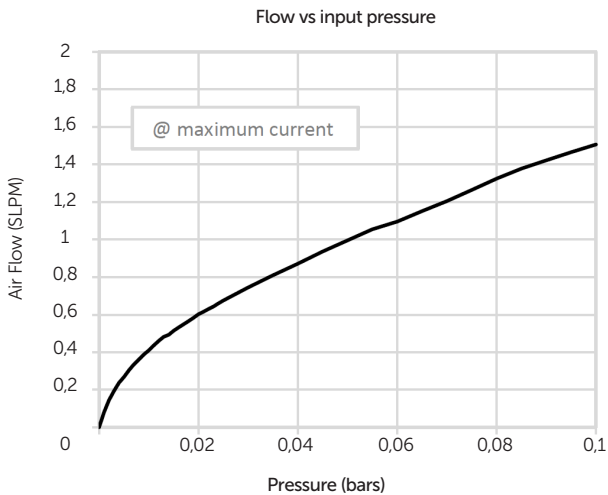

### Dimensions

Dimensions in mm  
 Projection/first angle

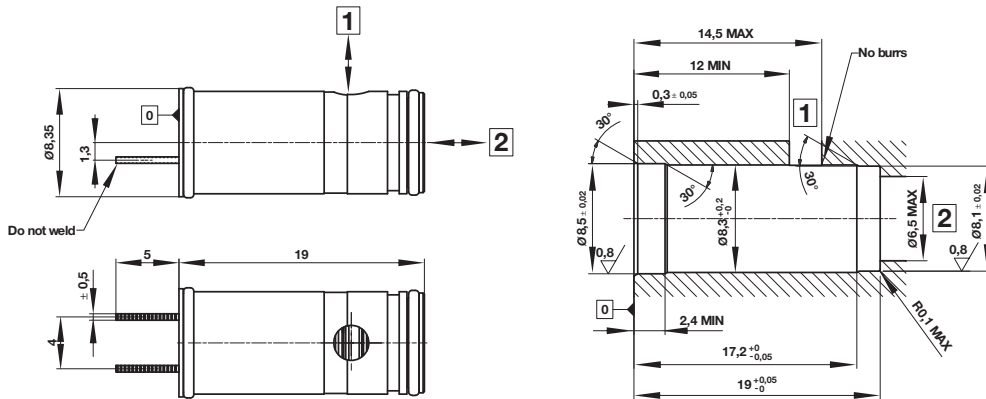

- 0 Face to be aligned by retaining means
- 1 INLET port
- 2 OUTLET port

**Note:**  
 The valve must be assembled in its housing with a lubricant that is compatible with the seals.

Max. axial Force supported by the valve: 75 [N].

### Warning

These products are intended for use in industrial compressed air and neutral gas systems only. Do not use these products where pressures and temperatures can exceed those listed under »Technical features/data«.

Before using these products with fluids other than those specified, for non-industrial applications, life-support systems, or other applications not within published specifications, consult IMI Plc., FAS MEDIC SA.

Through misuse, age, or malfunction, components used in fluid power systems can fail in various modes.

The system designer is warned to consider the failure modes of all component parts used in fluid power systems and to provide adequate safeguards to prevent personal injury or damage to equipment in the event of such failure.

System designers must provide a warning to end users in the system instructional manual if protection against a failure mode cannot be adequately provided.

System designers and end users are cautioned to review specific warnings found in instruction sheets packed and shipped with these products.